

SEYHAN

ZİNCİR DİŞLİ ve RULMAN SANAYİ
TİCARET LİMİTED ŞTİ.



Yüksek kalite en iyi fiyat – High quality best price
info@seyhanzincir.com.tr www.seyhanzincir.com.tr

HİZMET SEKTÖRLERİMİZ

(Factories) **Fabrikalar**

(Dealers) **Ara tedarikçiler**

(Bearing Sellers) **Rulmancılar**

(Hardware Sellers) **Hırdavatçılar**

(Machine manufacturers) **Makina İmalatçıları**

(Textile Sector) **Tekstil sektörü**

(Automotive Sector) **Otomotiv sektörü**

(Manufacturer of Hydraulic and Pneumatic machines) **Hidrolik ve pnömotik grubu imalatçıları**

(Lift and crane manufacturers) **Vinç aksamı grubu imalatçıları**

(Conveyer system manufacturers) **Taşıma sistemleri grubu imalatçıları**

(Concrete and concrete plants) **Beton ve beton üretim tesisleri**

(Elevator manufacturers) **Asansör imalatçıları**

(Manufacturers of Packing Machines) **Ambalaj grubu imalatçıları**

(Grinding machines manufacturers) **Değirmen makinası imalatçıları**



KAPLINLER
(COUPLINGS)

Yıldız Kaplinler
(Star Type Couplings)

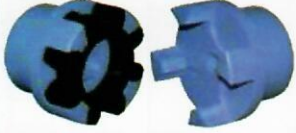

Yıldız Kaplinler
(Star Type Couplings)



Ayaklı Kaplinler (A Tipi)
(Type-A Couplings with Lep)



Ayaklı Kaplinler (A Tipi)
(Type-A Couplings with Lep)



B Tipi Kaplinler
(Type-B Couplings)

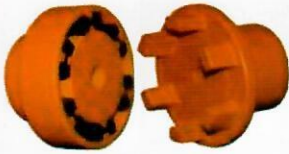

B Tipi Kaplinler
(Type-B Couplings)



E Tipi Kaplinler
(Type-E Couplings)

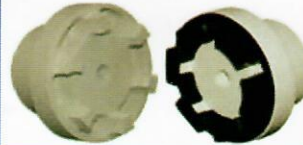

E Tipi Kaplinler
(Type-E Couplings)



H Tipi Kaplinler
(Type-H Couplings)

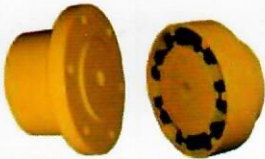

H Tipi Kaplinler
(Type-H Couplings)



i Tipi Kaplinler
(Type-I Couplings)



i Tipi Kaplinler
(Type-I Couplings)



Pernolu Tip Kaplinler
(Bold Type Couplings)



Pernolu Tip Kaplinler
(Bold Type Couplings)



Pernolu Tip Kaplinler
(Bold Type Couplings)



İşlenmiş Elastik Dişli Kaplinler
(Processed Elastic Gear Couplings)



ME Tipi Kaplinler
(Type-ME Couplings)



ME Tipi Kaplinler
(Type-ME Couplings)



Standart Elastik Dişli Kaplinler
(Elastic Gear Couplings)



Standart Elastik Dişli Kaplinler
(Elastic Gear Couplings)



SANAYİ TEKERLEKLERİ (INDUSTRIAL CASTERS)



Hafif Yük Tekerlekleri (Light Duty Casters)



(Polyamide reinforcement rubber wheel)



**Döküm Göbekli Beyaz
Lastikli Tekerlek**
(Cast reinforcement white rubber wheel)



**Döküm Göbekli
Lastik Tekerlek**
(Cast reinforcement rubber wheel)



**Poliamid Göbekli
Poliüretan Tekerlek**
(Polyamide reinforcement rubber wheel)



**Poliamid Jantlı
Lastik Tekerlek**
(Polyamide reinforcement rubber wheel)



Lastik
(Rubber)

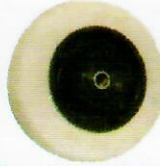

**Döküm Göbekli Beyaz
Lastikli Tekerlek**
(Cast reinforcement white rubber wheel)



**Döküm Göbekli
Lastik Tekerlek**
(Cast reinforcement rubber wheel)



Döküm Tekerlek
(Cast Wheel)



**Döküm Jantlı
Poliüretan Tekerlek**
(Cast reinforcement rubber wheel)



Poliamid
(Polyamide)



Lastik
(Rubber)



Döküm Tekerlek
(Cast Wheel)



Döküm Göbekli
(Cast Reinforcement)



**Sac Jantlı
Lastik Tekerlek**
(Steel Sheet Reinforcement
Rubber wheel)

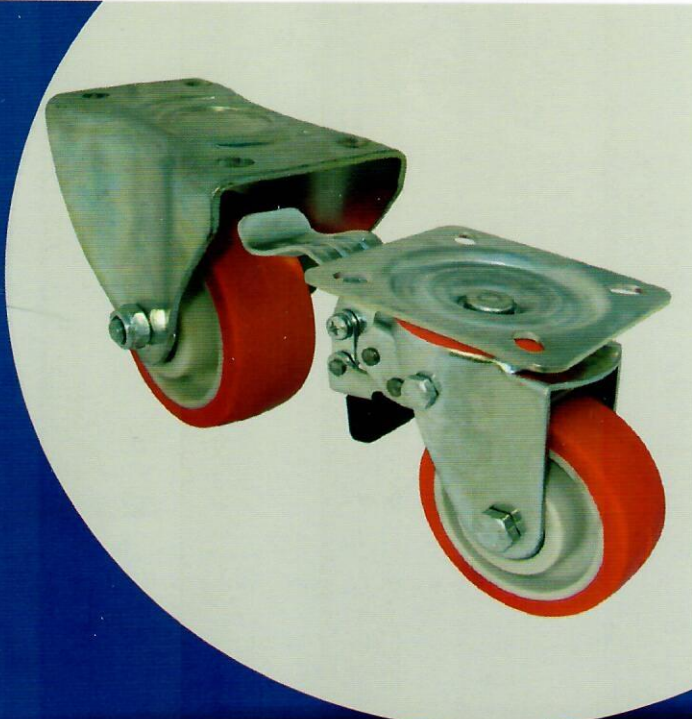

Poliamid
(Polyamide)



**Döküm Jantlı
Lastik Tekerlek**
(Cast reinforcement
rubber wheel)



**Poliamid Göbekli
Poliüretan Tekerlek**
(Polyamide reinforcement
Rubber Wheel)



**Döküm Göbekli
Lastik Tekerlek**
(Cast reinforcement
rubber wheel)



**Sac Jantlı
Lastik Tekerlek**
(Steel Sheet Reinforcement
Rubber Wheel)

SANAYİ TEKERLEKLERİ
(INDUSTRIAL CASTERS)

22 Serisi (22 Series)

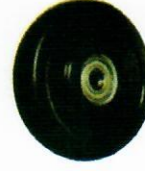

Lastik
(Rubber)



**Döküm Göbekli
Lastik Tekerlek**
(Cast Rubber Reinforcement
Rubber Wheel)



Döküm Tekerlek
(Cast Wheel)

30 Serisi (30 Series)

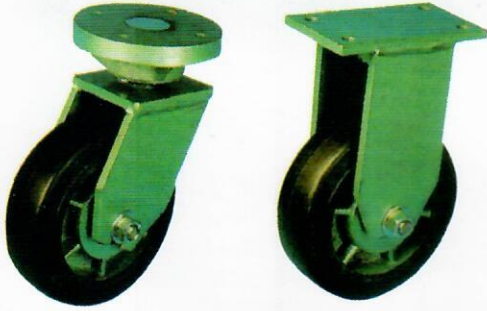

**Döküm Göbekli
Tekerlek**
(Cast Reinforcement Wheel)

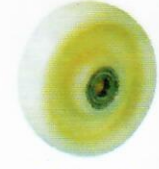

Poliamid
(Polyamide)



**Poliamid Göbekli
TPU Tekerlek**
(Polyamide Reinforcement
TPU Wheel)

31 Serisi (31 Series)

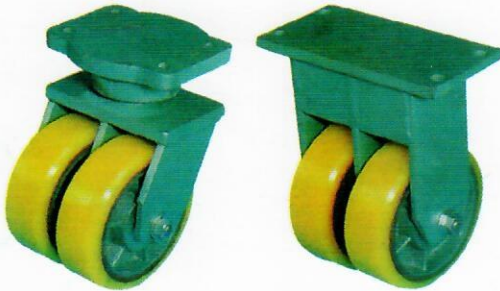

**Döküm Göbekli
Poliüretan Tekerlek**
(Cast Reinforcement Polyurethane Wheel)



**Döküm Göbekli
Lastik Tekerlek**
(Cast Reinforcement Rubber Wheel)



Döküm Tekerlek
(Cast Wheel)

32 Serisi (32 Series)

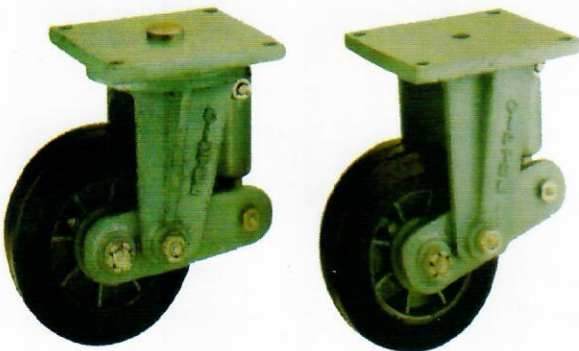

**Poliamid Göbekli
TPU Tekerlek**
(Polyamide Reinforcement TPU Wheel)



**Sac Jantlı
Lastik Tekerlek**
(Steel Sheet Reinforcement
Rubber Wheel)



**Döküm Göbekli
Lastik Tekerlek**
(Cast Reinforcement
Rubber Wheel)



Döküm Tekerlek
(Cast Wheel)



**Döküm Göbekli
Tekerlek**
(Cast Reinforcement Wheel)

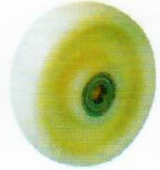

Poliamid
(Polyamide)

KAYIŞLAR (BELTS)



Dar Kesitli V Kayışlar
Narrow Section V Belts

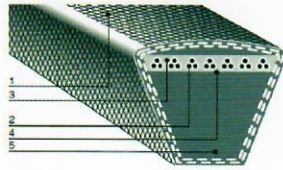

Power-Ace Dar Kesitli V Kayışlar
Narrow Section V Belts

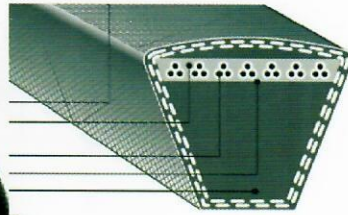

Bando Klasik Düz V Kayışlar
Classic Flat V Belts

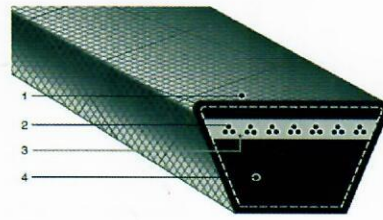

Bando Klasik ve Dar Tip Tırtıllı V Kayışlar
Classic and Narrow Toothed V Belts

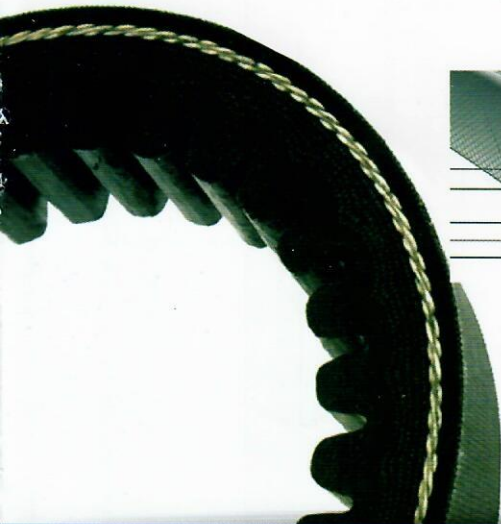
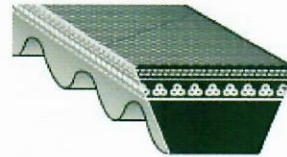

Özel Transmisyon Zincir Dişlileri
(Special Sprockets)



Özel Kremayer ve Helis Dişliler
(Special Rack and Pin Gears- Helical Gears)



Metal ve Hidrolik Aksesuarlar
(Metal and Hydraulic Accesories)



Özel Modül Dişliler
(Special Module Gears)



ZİNCİR DİŞLİLER (S P R O C K E T S)



Standart Transmisyon Zincir Dişlileri (Standard Sprockets)



Kremayerler (Rack Gears)



Standart Triger Kasnaklar (Standart Timing Belt Pulleys)



Standart Zincirler (Standart Chains)



Konik Burç ve Konik Kilitler (Conic Bushings and Conic Locks)



Göbekli ve Düz Modül Dişliler (Straight Cut Gears)

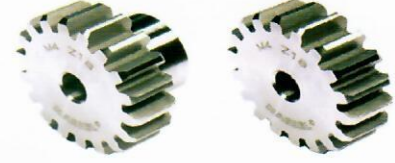

Konik Burçlu Kasnaklar (Conic Bushings Pulleys)



Kör Kasnaklar (Blind Pulleys)



Konik Burçlu Zincir Dişlileri (Conic Bushings Sprockets)



Konik Burçlu Triger Kasnaklar (Conic Bushing Timing Belt Pulleys)



RULMANLAR (BEARINGS)



Sanayi Rulmanları (Industrial Bearings)



Yataklı Rulmanlar (Bearings with Housing)

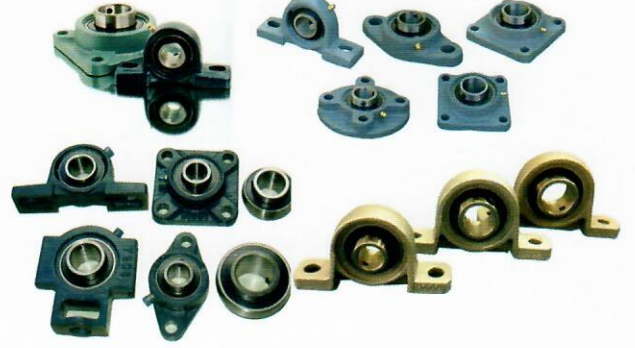

Lineer Yataklar ve Arbalar (Monorial System and Carriages)

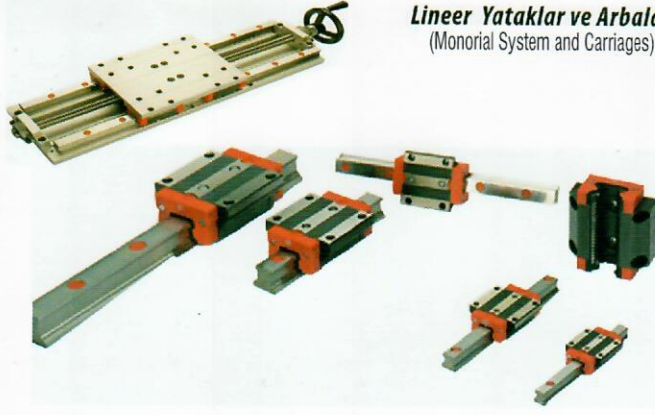

Vidalı ve Lineer Miller (Ball screw Systems and Linear Systems)

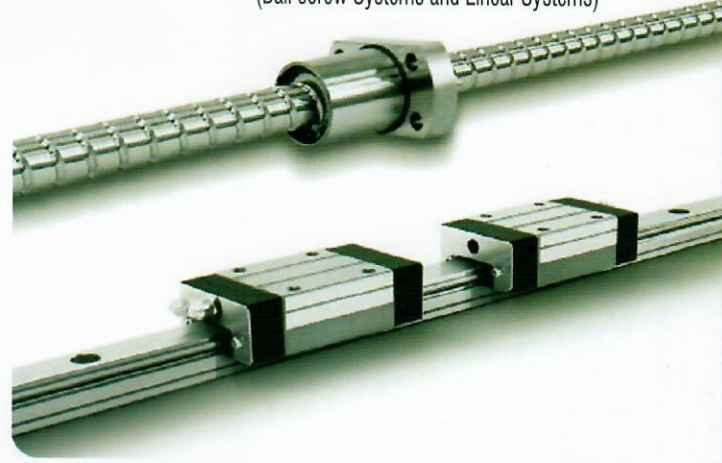

(Linear Bearings) Lineer Rulmanlar



Mafsal Rulmanları



TSUBAKI

Türkiye Distribütörü



KEÇELER
(FELTS)



LINEER RULMAN ve YATAKLAR

(LINEER BEARING AND BED)

(GTEN / VİDALI MİL VE HASSAS BİLYALI SOMUNLAR)



(STAF LINEER KIZAK ve ARABALAR)

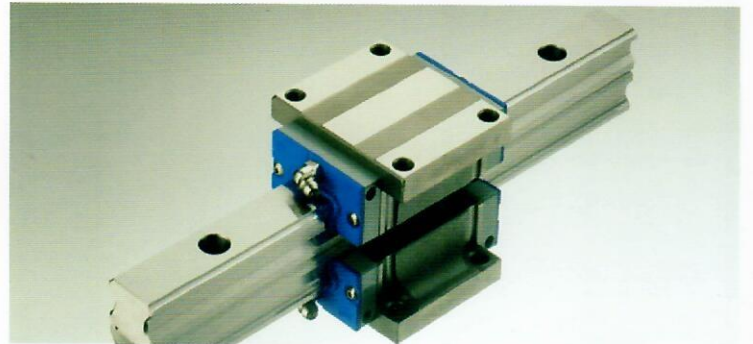
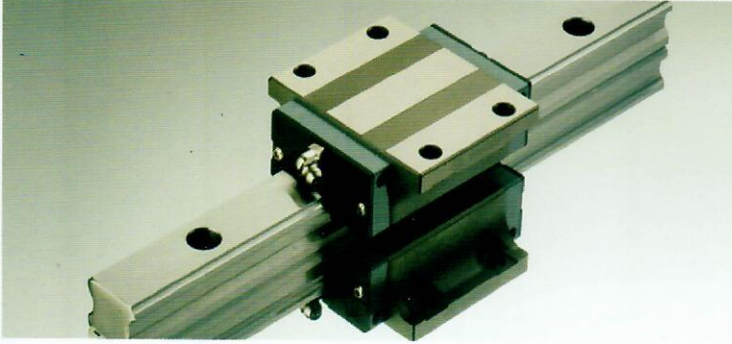

(SAMICK / LINEER RULMAN VE YATAKLAR)

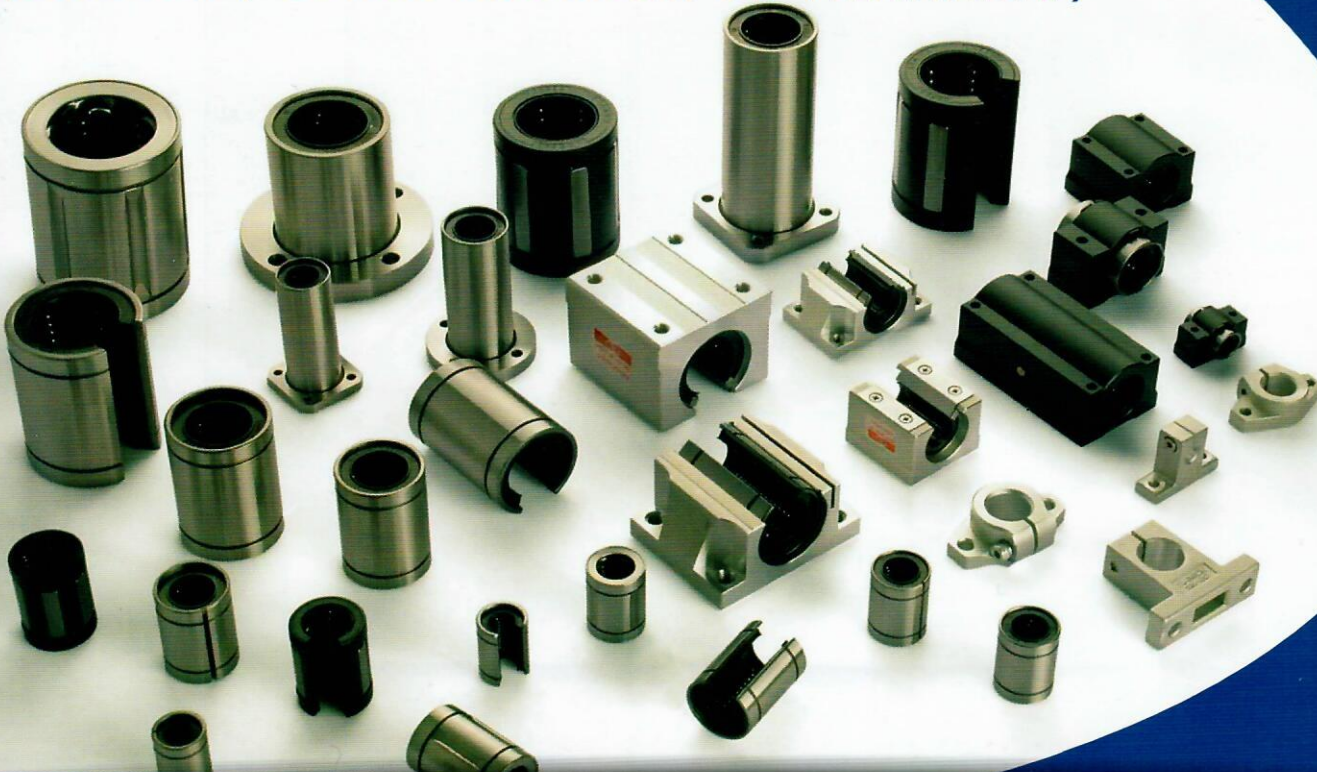

Standart Tip Makaralı Zincirler
Standard Type Roller Chains

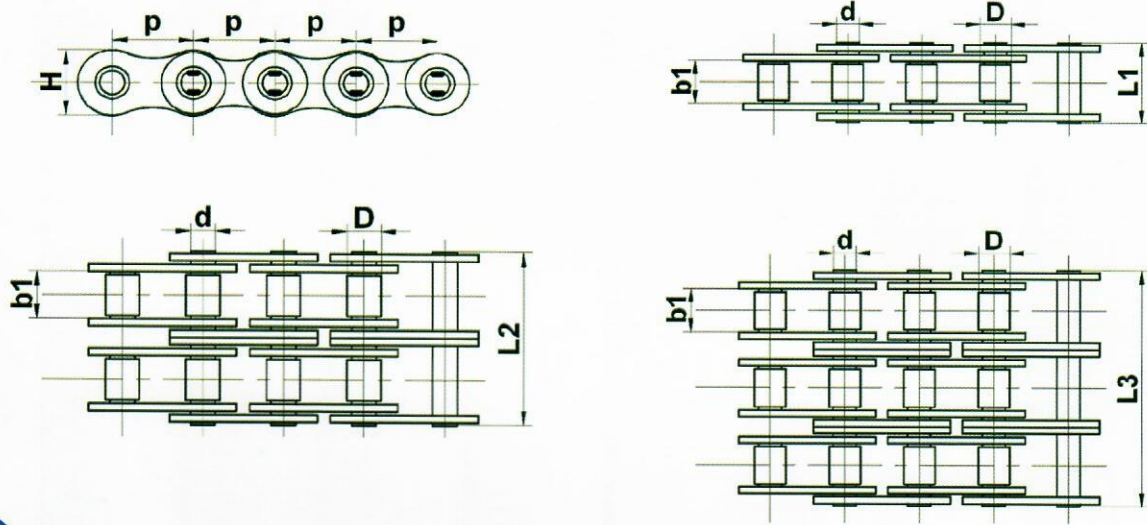

ISO Standartlarında Makaralı Zincir Serileri

(Roller Chain Series in ISO Standarts)

ISO NO.	p	d	b1	D	L1	L2	L3	H
04B 6 mm	6,00	1,85	2,80	4,00	7,40	---	---	5,00
05B 8 mm	8,00	2,31	3,00	5,00	8,60	14,30	---	7,10
06B 3/8"	9,53	3,28	5,72	6,35	13,50	23,80	34,00	8,20
08B 1/2"	12,70	3,66	7,75	8,51	17,00	31,00	44,90	11,80
10B 5/8"	15,88	5,08	9,65	10,16	19,60	36,20	52,80	14,70
12B 3/4"	19,05	5,72	11,68	12,07	22,70	42,20	61,70	16,10
16B 1"	25,40	8,27	17,02	15,88	36,10	68,00	99,90	21,00
20B 1 1/4"	31,75	10,19	19,56	19,05	43,20	79,00	116,00	26,40
24B 1 1/2"	38,10	14,63	25,40	25,40	53,40	101,00	150,00	33,40
28B 1 3/4"	44,45	15,90	30,99	27,94	65,10	124,00	184,00	37,00
32B 2"	50,80	17,81	30,99	29,21	67,40	126,00	184,00	42,20
40B 2 1/2"	63,50	22,89	38,10	39,37	82,60	154,00	227,00	52,90
48B 3"	76,20	29,24	45,72	48,26	99,10	190,00	281,00	63,80



(Sprcket Diameters as Pitch)
Hatvelerine Göre Zincir Dişli Çapları

Z	6 6mm	8 8mm	3/8" 9,53	1/2" 12,7	5/8" 15,88	3/4" 19,05	1" 25,4	1 1/4" 31,75	1 1/2" 38,1	1 3/4" 44,45	2" 50,8
8	18	24	28	37,2	47	57,6	77	98,1	115		
9	19,9	26,6	31	41	52,6	62	85	108	126,4	158,8	186
10	21,7	29,2	34	45,2	57,5	69	93	117,9	138	170,5	199,2
11	23,6	31,7	37	48,7	63	75	99,5	127,8	150	182,4	212,9
12	25,4	34,2	40	53	68	81,5	109	137,8	162	194,8	226,8
13	27,3	36,7	43	57,4	73	87,5	117	147,8	174,2	212,4	245,2
14	29,2	39,2	46,3	61,8	78	93,6	125	157,8	186,2	225,3	261,1
15	31	41,7	49,3	65,5	83	99,8	133	167,9	196,2	238,8	276,4
16	33	44,3	52,3	69,5	88	105,5	141	177,9	210,3	252	291,6
17	35	46,8	55,3	73,6	93	111,5	149	187,9	222,3	265,5	306,9
18	36,9	49,3	58,3	77,8	98,3	118	157	198	234,3	278,9	322,4
19	38,6	51,9	61,3	81,7	103,3	124,2	165,2	208,1	246,5	292,6	337,9
20	40,7	54,4	64,3	85,8	108,4	129,7	173	218,1	258,6	310,7	356,9
21	42,6	57	68	89,7	113,4	136	181,2	228,2	270,6	324,4	372,6
22	44,5	59,5	71	93,8	118	141,8	189,3	238,3	282,7	338,3	388,6
23	46,4	62	73,5	98,2	123,5	149	197,5	248,3	294,8	352,1	404,4
24	48,3	64,6	77	101,8	128,3	153,9	205,5	258,4	306,8	366	420,2
25	50,2	67,5	80	105,8	134	160	213,5	268,5	319	380	436,2
26	52,1	69,5	83	110	139	165,9	221,6	278,6	331	393,7	451,9
27	54	72,2	86	114	144	172,3	229,6	288,6	343,2	407,7	468,4
28	55,9	74,8	89	118	148,7	178	237,7	298,7	355,2	421,7	484,1
29	57,8	77,3	92	122	153,8	184,1	245,8	308,8	367,3	435,6	500,1
30	59,8	79,8	94,7	126,1	158,8	190,5	254	318,9	379,5	449,6	516,1
31	61,7	82,4	96,3	130,2	163,9	196,3	262	329	391,6	463,6	532,1
32	63,6	84,9	101,3	134,3	168,9	203,3	270	339,1	403,7	477,6	548,1
33	65,5	87,5	104,3	138,4	174,5	209,2	278,5	349,2	415,8	491,8	564,1
34	67,4	90	107,3	142,6	179	214,6	287	359,3	427,8	505,7	580,2
35	69,3	92,5	110,4	146,7	184,1	221	296,2	369,4	440	519,7	596,2
36	71,2	95	113,4	151	189,1	226,8	304,6	379,5	452	533,7	612,2
37	73,1	97,6	116,4	154,6	194,2	232,9	312,6	389,5	464,2	547,7	628,4
38	75	100,2	119,5	158,6	199,2	239	320,7	399,6	476,2	561,9	644,4
39	76,9	102,7	122,5	162,7	204,2	245,1	328,8	409,7	488,5	575,9	660,4
40	78,9	105,5	125,5	166,8	209,3	251,3	336,9	419,8	500,6	589,8	676,9
41	80,6	107,8	128,5	171,4	214,8	257,3	345	429,9	512,6	604	692,9
42	82,7	110,4	131,6	175,4	219,9	264,5	353	440	524,7	618	708,9
43	84,7	112,9	134,6	179,7	224,9	270,5	361,1	450,1	536,8	632,2	725,2
44	86,6	115,5	137,6	183,9	230	276,5	369,1	460,2	549	646,2	741,2
45	88,5	118	140,7	188	235	282,5	377,1	470,3	561,2	660,2	757,2
46	90,4	120,6	143,7	192,1	240,1	287,9	385,2	480,4	573,3	674,4	773,5
47	92,3	123,1	146,7	196,2	245,1	294	393,2	490,5	585,4	688,4	789,5
48	94,2	125,6	149,7	200,3	250,2	300,1	401,3	500,6	597,4	702,6	805,5
49	96,1	128,2	152,7	204,3	255,2	306,2	409,3	510,7	609,5	716,6	821,7
50	98	130,7	155,7	208,3	260,3	312,3	417,4	520,8	621,7	730,8	837,7
51	99,9	133,3	158,7	212,1	265,3	318,4	425,5	530,9	633,8	744,8	853,7
52	101,8	135,8	161,8	216,1	270,4	324,5	433,6	541	646	758,7	870
53	103,7	138,4	164,8	220,2	275,4	330,5	441,7	551,1	658	773	886
54	105,6	140,9	167,8	224,1	280,5	336,6	448,3	561,2	670,2	786,9	902,2
55	107,6	143,5	170,8	228,1	285,5	342,7	457,9	571,3	682,3	801,2	918,2
56	109,5	146	173,8	232,2	290,6	348,7	466	581,4	694,4	815,1	934,5
57	111,4	148,6	176,9	236,4	296	355,4	474	591,5	706,5	829,3	950,5
58	113,3	151	179,9	240,5	300,7	361,5	482,1	601,6	718,6	843,6	966,5
59	115,2	153,6	183	244,5	305,7	367,5	490,2	611,7	730,7	857,5	982,7
15	117,1	156,2	186	248,6	310,8	373	498,3	621,8	742,8	871,7	998,7

Z	6 6mm	8 8mm	3/8" 9,53	1/2" 12,7	5/8" 15,88	3/4" 19,05	1" 25,4	1 1/4" 31,75	1 1/2" 38,1	1 3/4" 44,45	2" 50,8
61		159,5	189,3	252,5	316,3	379,5	506,5	633,8	757,2	885,7	1015
62	120,9	162	192,1	256,9	321,4	385,1	514,5	642	767,2	899,9	1031
63		164,6	195,4	260,4	326,2	391,7	522,5	653,8	781,3	913,9	1047,3
64	124,7	167,1	198,2	265,1	331,5	397,2	530,7	662,2	791,3	928,2	1063,3
65	126,6	169,6	201,6	269	336,5	403,2	538,8	672,3	803,4	942,1	1079,5
66	128,5	172,2	204,6	273	341,6	409,3	546,8	682,4	815,6	956,3	1095,5
67		174,8	207,5	276,6	346,5	415,8	554,8	692,4	828,8	970,6	1111,8
68	132,4	177,3	210,7	281	351,7	421,4	562,9	702,6	839,8	984,5	1127,8
69		179,9	213,6	284,8	356,4	428	571	714,3	854	998,8	1144
70	136,2	182,4	216,7	289	361,8	433,6	579,2	722,8	864,2	1012,7	1160
71		184,9	219,5	292,6	366,5	440,2	587	734,6	878,1	1026,9	1176,3
72	140	187,5	222,8	297,2	371,9	447	595,4	743,1	888,4	1040,9	1192,3
73		190	225,6	300,8	376,7	452,1	603,3	754,7	902,5	1055,2	1208,5
74		192,5	228,6	304,8	381,8	458,2	611,1	764,8	914,4	1069,4	1224,8
75	145,7	195,1	231,9	309,2	387,1	463,9	619,7	773,3	924,8	1083,3	1240,8
76	147,6	197,7	234,9	313,3	392,1	469,9	627	783,5	936,9	1097,5	1257,1
77		200,2	237,8	317	396,8	476,5	635,5	795	950,7	1111,5	1273,1
78	151,5	202,8	241	321,4	402,2	482,1	643,3	805,2	962,9	1125,8	1289,3
79		205,2	243,9	324,9	406,9	488,5	651,5	815,1	975,1	1140	1305,3
80	155,3	207,9	247,1	329,4	412,3	494,2	660	823,9	985,4	1154	1321,8
81	164,8	210,3	249,7	333	417,1	500,7	667,8	835,4	999	1168,2	1338,1
82		212,9	252,8	337,1	421,9	506,8	675,9	845,6	1011,2	1182,4	1354,1
83		215,4	255,8	341,1	427	512,6	683,6	855,8	1023,1	1196,4	1370,4
84		217,9	258,9	345,2	432,1	518,7	691,9	865,9	1035,3	1210,6	1386,6
85	164,8	220,6	262,2	349	437,8	524,5	699,9	874,4	1046	1224,6	1402,6
86		223	264,9	353,1	442,2	530,9	708,2	886	1059,5	1238,9	1418,9
87		225,6	268	357,1	447,3	537	716,3	896	1071,7	1253	1434,9
88		228,1	271	361,2	452,4	543,1	724,2	906,3	1083,9	1267	1451,1
89		230,7	274,1	365,3	457,2	548,9	732,3	916,2	1095,8	1281,2	1467,1
90	174,4	233,4	277,4	369,9	462,8	554,8	740,3	924,9	1108	1295,4	1483,4
91		235,7	280,2	373,4	467,4	561,1	748,6	936,5	1120,2	1306,4	1499,6
92		238,3	283,2	377,5	472,5	567,2	756,7	946,4	1132,1	1320,6	1515,6
93		240,8	286	381,5	477,5	573,3	766,6	956,8	1144,3	1337,6	1531,9
94		243,9	289,1	385,6	482,6	579,4	772,7	966,8	1156,5	1351,8	1547,9
95	183,9	246,1	292,5	390,1	488,5	585,1	781,1	975,4	1167,3	1366	1564,2
96		248,4	295,2	393,5	492,8	591,3	789	986,8	1180,6	1380	1580,2
97		251	298,2	397,5	497,8	597,4	797,1	997	1192,8	1394,2	1596,4
98		253,5	301,3	401,6	502,7	603,5	805	1007,1	1204,7	1408,4	1612,7
99		256,1	304,3	405,7	507,8	609,6	813,1	1017,3	1216,9	1422,4	1628,7
100	193,5	258,9	307,7	410,3	513,4	615,4	821,1	1026	1229,1	1436,6	1644,9
101		261,1	310,4	413,8	517,9	621,8	829,3	1037,4	1241,3	1450,9	1660,9
102		263,7	313,5	417,9	523	627,7	837,2	1047,5	1253,3	1464,9	1677,2
103		266,2	316,5	421,9	528,1	633,8	845,3	1057,7	1265,5	1479,1	1693,4
104		268,8	319,5	426	533,2	639,9	853,5	1067,6	1277,7	1493,3	1709,4
105		271,3	322,6	430	538	646	861,6	1077,7	1289,6	1507,3	1725,7
106		273,8	325,4	433,9	543,1	652	869,7	1087,9	1301,8	1521,5	1741,7
107		276,4	328,4	437,9	548,2	658,1	877,8	1098,1	1314	1535,5	1758
108		278,9	331,5	442	553,2	664,2	885,7	1108	1325,9	1549,7	1774,2
109		281,5	334,5	446	558,2	670,1	893,9	11			

ST

Bilyalı Masaüstü Taşıyıcılar



PARÇA NO	BİLYA ÇAPI	D mm	D1 mm	h mm	H mm	YÜK KAP. KG
SP 12 B	12,7 mm	22	-	5,5	17	20
SP 15 B	15,8 mm	24	31,5	10	21	60
SP 22 B	22,2 mm	36	45	9,8	31	180
SP 25 B	25,4 mm	38	45	13,5	31	200
SP 30 B	30 mm	45	55	14	37	350
SP 45 B	44,4 mm	62	75	19	54	550
SP 60 B	60 mm	100	117	48	77	1500
SP 15 C Paslanmaz	15,8 mm	24	31,5	10	21	60
SP 22 C Paslanmaz	22,2 mm	36	45	9,8	31	180
SP 30 C Paslanmaz	30 mm	45	55	14	37	350
SP 15 Plastik Bilyalı	15,8 mm	24	31,5	10	21	
SP 22 Plastik Bilyalı	22,2 mm	36	45	9,8	31	
10015	15,8 mm				21	

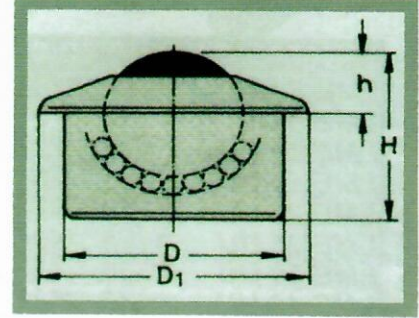

SP 12 A-FL

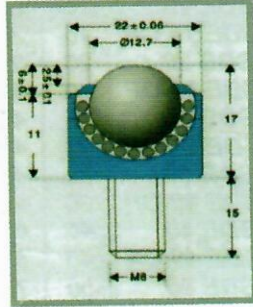

SP 15 A-FL

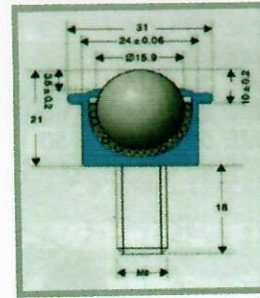

Yük Kapasitesi 260 KG

IA 19

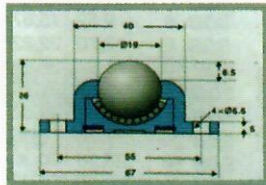

Yük Kapasitesi 260 KG

IA 25

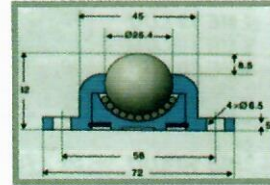

SEYHAN
ZİNCİR DİŞLİ ve RULMAN SANAYİ
TİCARET LİMİTED ŞTİ.